



# Thule Rapid System Kit 4005

# > Instructions

SUBARU Forester, 5-dr SUV, 03-07

This kit is only for vehicles with flush or integrated side railing.

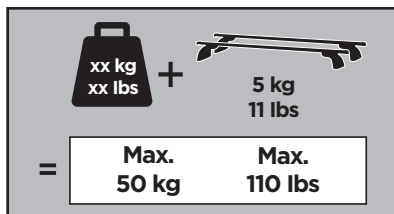
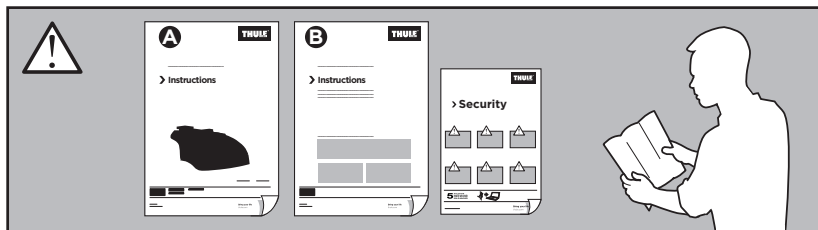

ISO 11154-E

184005

C.20130228  
509-4005-02

Bring your life  
thule.com

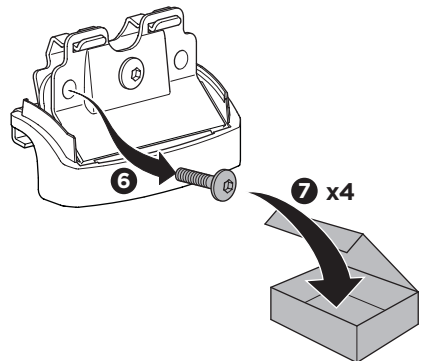
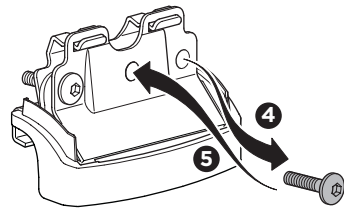
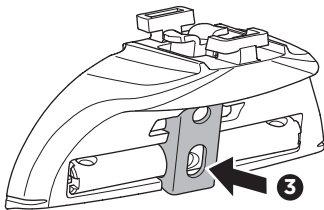
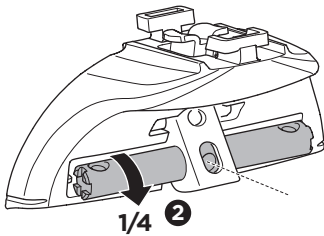
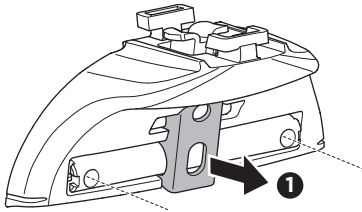
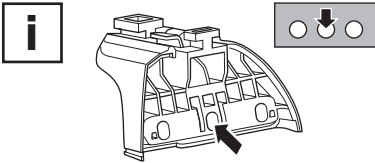
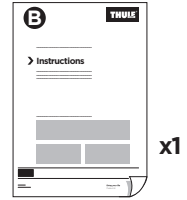
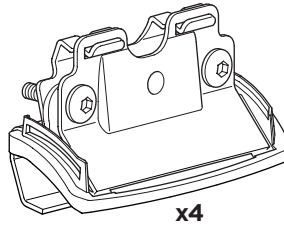
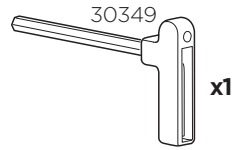
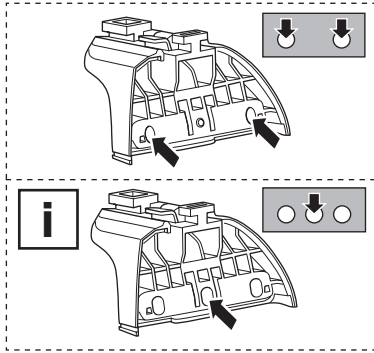

**1**

<b>EN</b> Only a few turns	<b>ET</b> Ainult mõni pööre	<b>RO</b> Doar câteva rotiri
<b>DE</b> Nur wenige Umdrehungen	<b>LV</b> Tikai daži apgriezieni	<b>HU</b> Csak néhány fordítás
<b>FR</b> Quelques tours uniquement	<b>LT</b> Tik keli pasukimai	<b>EL</b> Μόνο λίγες περιστροφές
<b>NL</b> Slechts enkele slagen	<b>PL</b> Wystarczy kilka obrotów	<b>TR</b> Yalnızca birkaç tur
<b>IT</b> Solo qualche giro	<b>RU</b> Только несколько оборотов	بعض دورات فقط <b>AR</b>
<b>ES</b> Sólo algunas vueltas	<b>UK</b> Лише декілька обертів	רק מספר סיבובים <b>HE</b>
<b>PT</b> Noções básicas	<b>BG</b> Само няколко завъртания	<b>ZH</b> 仅几圈
<b>SV</b> Endast några varv	<b>CS</b> Pouze několik otáček	<b>JA</b> 2～3回転のみ
<b>DK</b> Kun nogle få omgange	<b>SK</b> Len niekoľko otáčok	<b>KO</b> 몇 번만 돌리면 됨
<b>NE</b> Bare noen få omdreininger	<b>SL</b> Le nekaj obratov	<b>TH</b> เพียงสองสามรอบ
<b>FI</b> Vain muutama kierros	<b>HR/BIH</b> Samo nekoliko okreta	

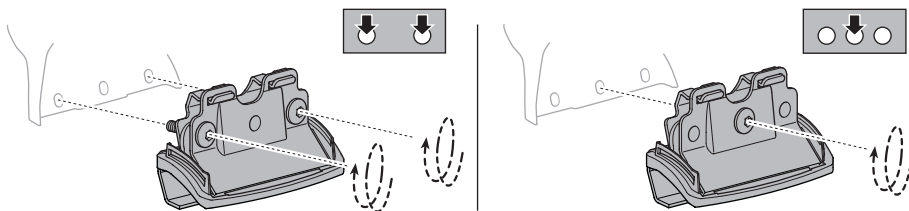
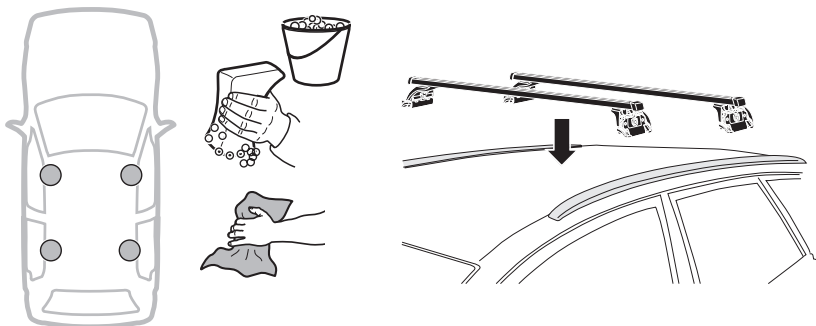
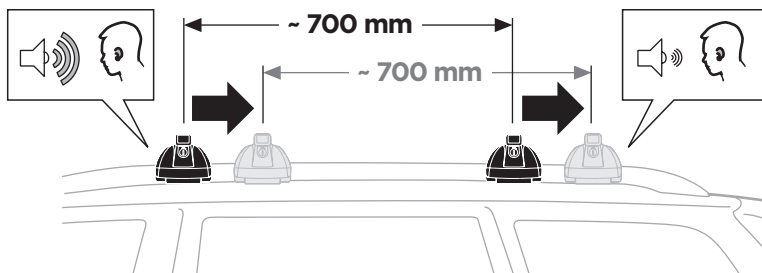
**i****2**

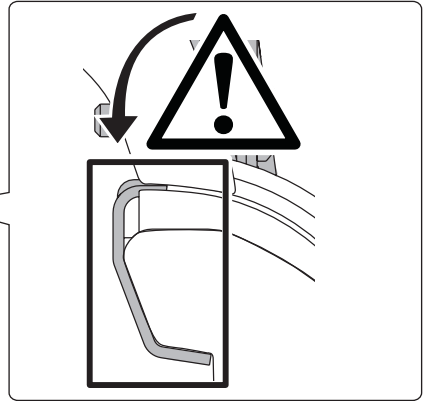
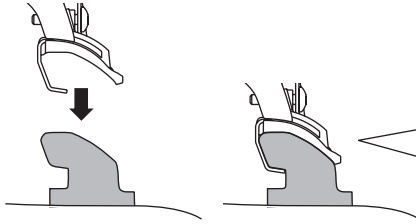
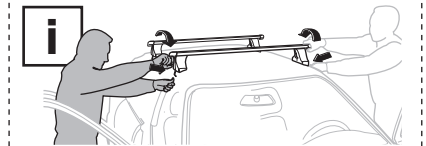
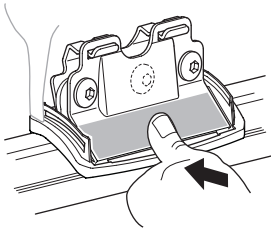
**A****B**

**EN** Tighten alternately  
**DE** Die Schrauben abwechselnd anziehen  
**FR** Serrer alternativement chaque côté  
**NL** Afwisselend aan de linker- en de rechterkant aandraaien

**IT** Alternare il serraggio delle viti

**ES** Apretar alternativamente

**PT** Aperte alternadamente

**SV** Dra åt växelvis

**DK** Spænd skiftevis

**NE** Trekk til vekselvis

**FI** Kierrä vuorotellen

**ET** Pinguldage vaheldumisi

**LV** Pievelciēt pamīšus

**LT** Užsukinėkite pakaitomis

**PL** Śruby dokręcaj naprzemiennie

**RU** Затягивайте попеременно

**UK** Затягти по чергово

**BG** Затенете последователно

**CS** Pokręťta bagazníka dokręcaj dokręcaj naprzemiennie.

**SK** Doťahujte striedavo

**SL** Privijajte izmenično

**HR/BiH** Naizmjerno zategnite

**RO** Strângeți alternativ

**HU** Egymástól függetlenül szorítandó

**EL** Ξφίγγετε εναλλάξ

**TR** Dönüşümlü sıkın

إحكام الربط بالتناوب **AR**

תוקן לסירוקן **HE**

**ZH** 交替拧紧

**JA** 自動固定

**KO** 번갈아 조이기

**TH** ซักนั้แบบสลับ

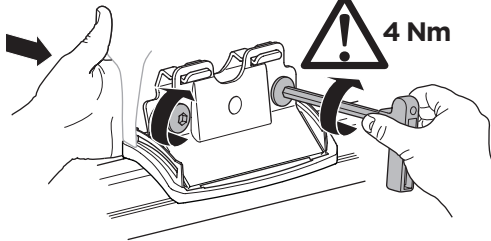
**C****C**