

# Kit 1398

SEAT León, 5-dr Hatchback, 05-

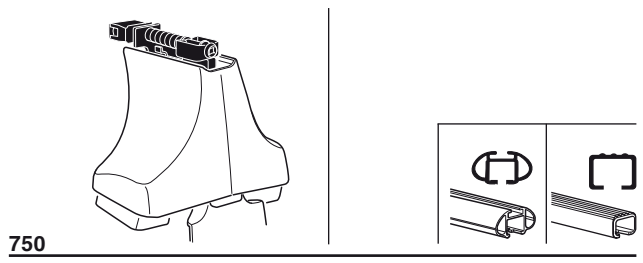

**Kit**

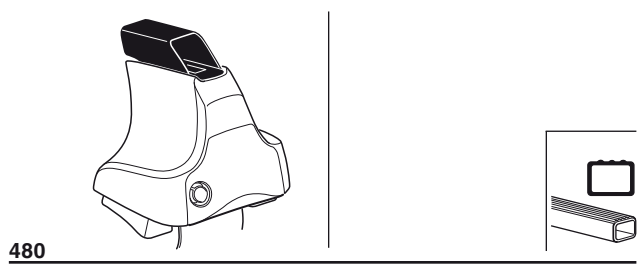
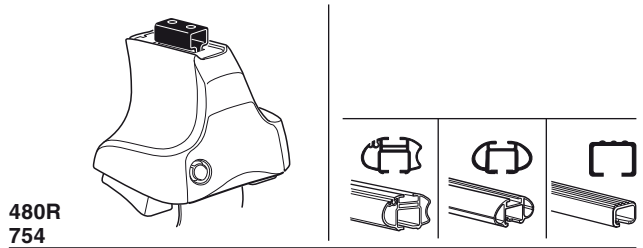

**3**



754

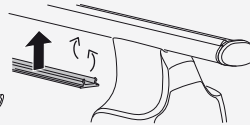
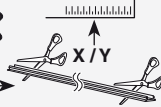

750

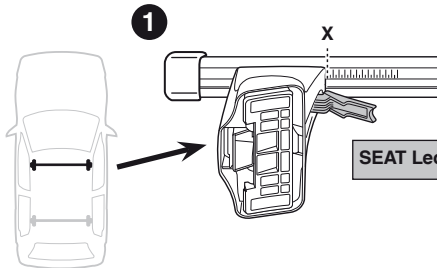

**1**

X

**2**

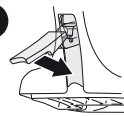

SEAT León, 5-dr Hatchback, 05-

X

37

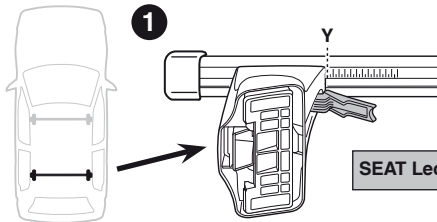

**1**

Y

**2**

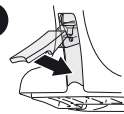

SEAT León, 5-dr Hatchback, 05-

Y

32



480R



480

**1**

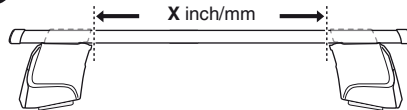

**2**

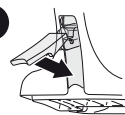

SEAT León, 5-dr Hatchback, 05-

X inch

X mm

40 1/4"

1021 mm

**1**

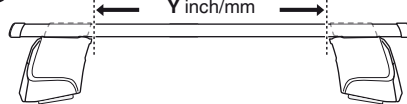

**2**

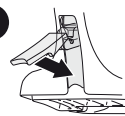

SEAT León, 5-dr Hatchback, 05-

Y inch

Y mm

38 1/4"

971 mm

# 4

SEAT León, 5-dr Hatchback, 05-

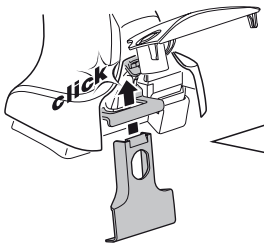
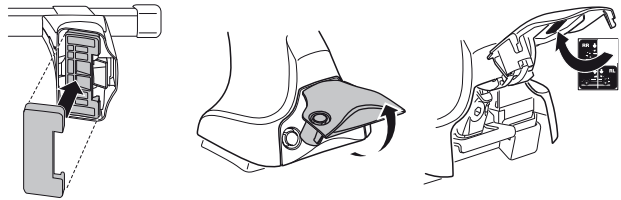
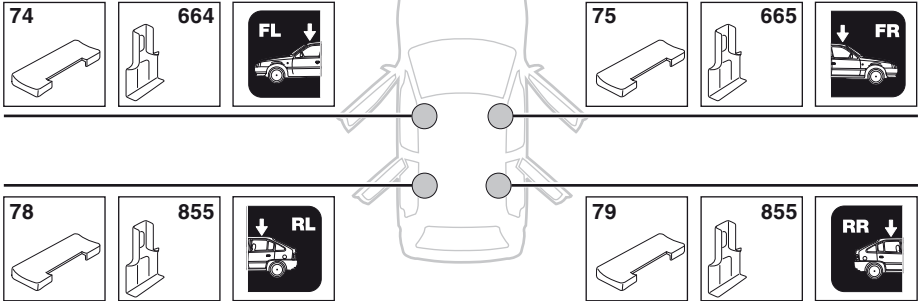

5



	X mm	Y mm	X inch	Y inch
SEAT León, 5-dr Hatchback, 05-	205 mm	710 mm	8 1/8"	28"

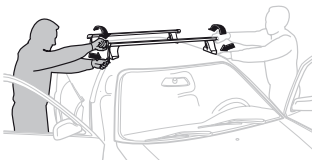
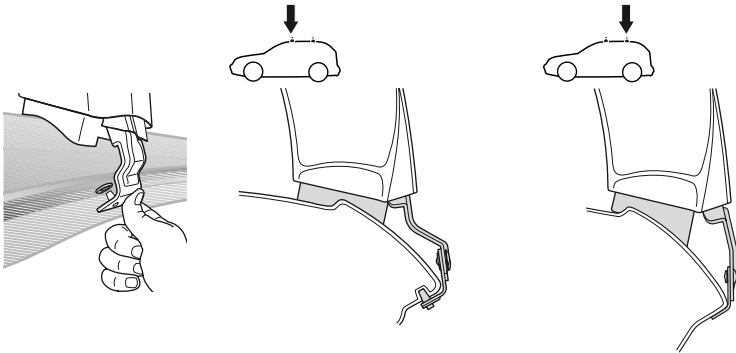
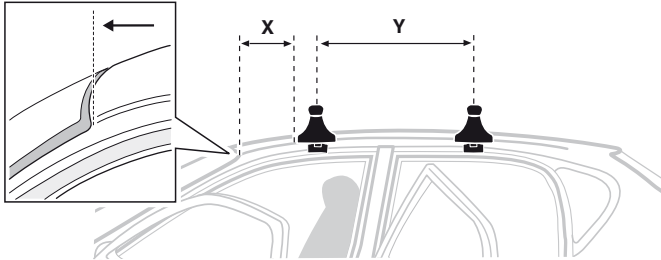

- |              |   |            |   |
|--------------|---|------------|---|
| <b>GB/US</b> | Tighten alternately                                     | <b>CZ</b>  | Pokřeřta багаžníka dokřeřaj dokřeřaj napřezmiennie. |
| <b>D</b>     | Die Schrauben abwechselnd anziehen                      | <b>SK</b>  | Dotahujte striedavo                                 |
| <b>F</b>     | Serrer alternativement chaque côté                      | <b>SLO</b> | Privijajte izmenično.                               |
| <b>NL</b>    | Afwisselend aan de linker- en de rechterkant aandraaien | <b>HR</b>  | Naizmjenično zategnite                              |
| <b>I</b>     | Alternare il serraggio delle viti                       | <b>HU</b>  | Egymástól függetlenül szorítandó                    |
| <b>E</b>     | Apretar alternativamente                                | <b>GR</b>  | Σφιγγετε εναλλάξ                                    |
| <b>PT</b>    | Aperte alternadamente                                   | <b>TR</b>  | Dönüşümlü sıkın                                     |
| <b>S</b>     | Dra åt växelvis   | <b>中文</b>  | 交替拧紧  |
| <b>FIN</b>   | Kierrä vuorotellen                                      | <b>한국어</b> | 변갈아 가며 조이십시오.                                       |
| <b>EST</b>   | Pinguldage vaheldumisi                                  | <b>日本語</b> | 交互に締め付けてください。                                       |
| <b>LAT</b>   | Pielieciet pamišus                                      | <b>ไทย</b> | ขันในแบบสลับ  |
| <b>LIT</b>   | Užsukinėkite pakaitomis                                 |            |   |
| <b>PL</b>    | Śruby dokřeřaj napřezmiennie                            |            |   |
| <b>RU</b>    | Затягивайте попеременно                                 |            |   |

6



480R/754



480

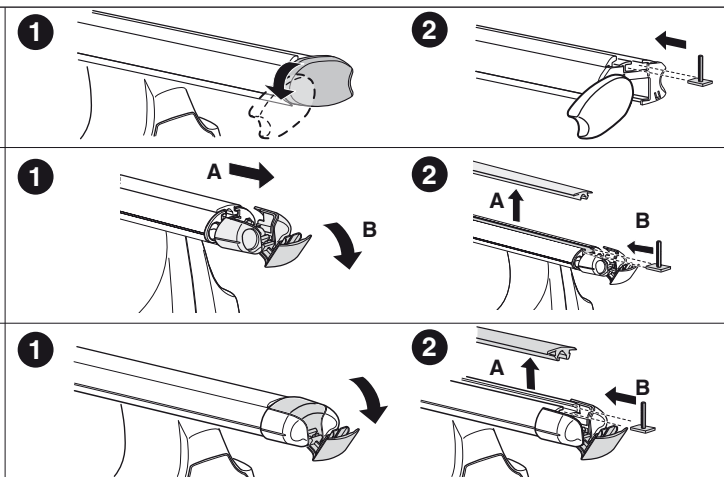
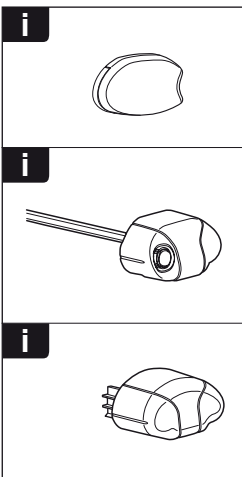
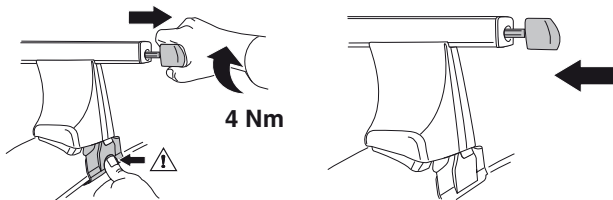
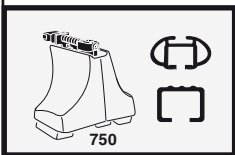
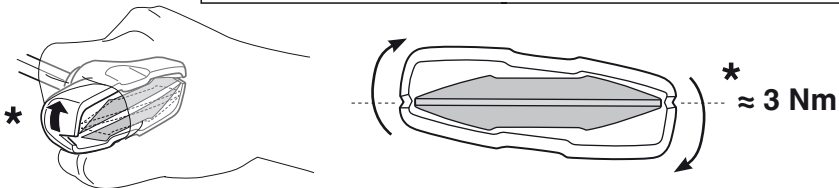
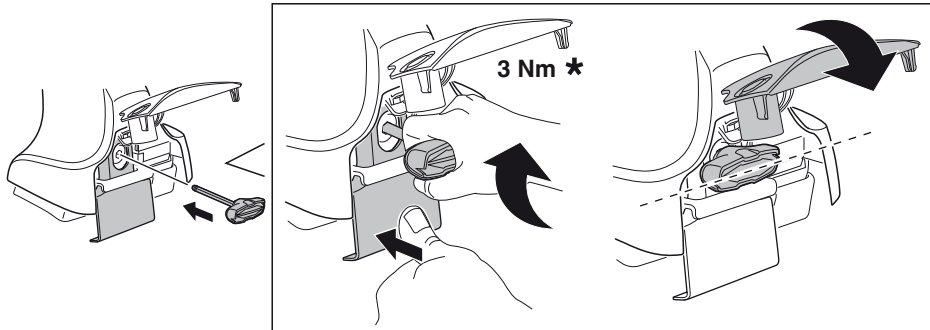

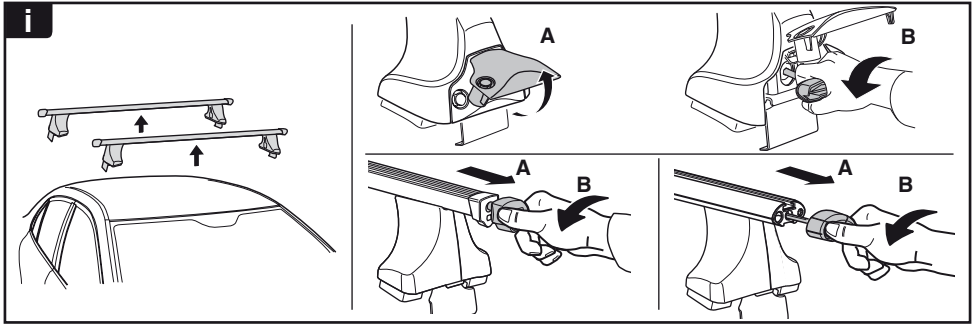

**THULE**  
SWEDEN  
**ONE  
KEY  
SYSTEM**



- 544 (x4)
- 596 (x6)
- 588 (x8)
- NA 510 (x10)
- EUR 452 (x12)
- ASIA



WW ▶ Thule Sweden AB, Box 69, 330 33 Hillerstorp, SWEDEN  
NA ▶ Thule Inc., 42 Silvermine Road, Seymour, Connecticut 06483, USA

info@thule.com  
customer.service@thule.com

www.thule.com