



Thule XT Kit 3017

> Instructions

CITROËN C5, 4-dr Sedan, 08-

CITROËN C6, 5-dr Hatchback, 05-12

PEUGEOT 207, 3-dr Hatchback, 06-12

PEUGEOT 207, 5-dr Hatchback, 06-12

PEUGEOT 308, 3-dr Hatchback, 07-13

PEUGEOT 308, 5-dr Hatchback, 07-13

PEUGEOT 407, 4-dr Sedan, 04-10

PEUGEOT 3008, 5-dr SUV, 09-

PEUGEOT 5008, 5-dr MPV, 09- (Without integrated railing)

This kit is only for vehicles with fixpoint mounting.

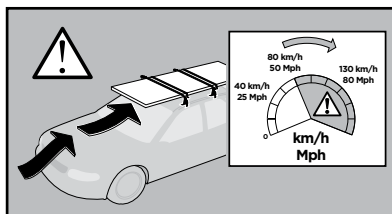
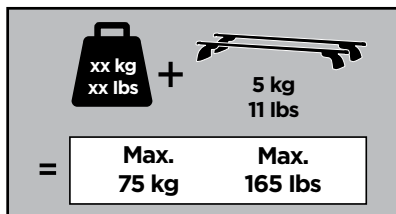
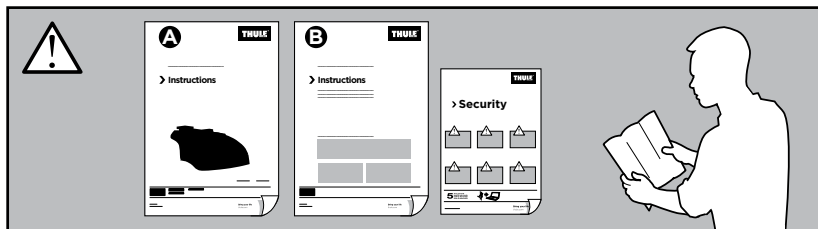

ISO 11154-E

183017

C.20151222
509-3017-05

Bring your life
thule.com

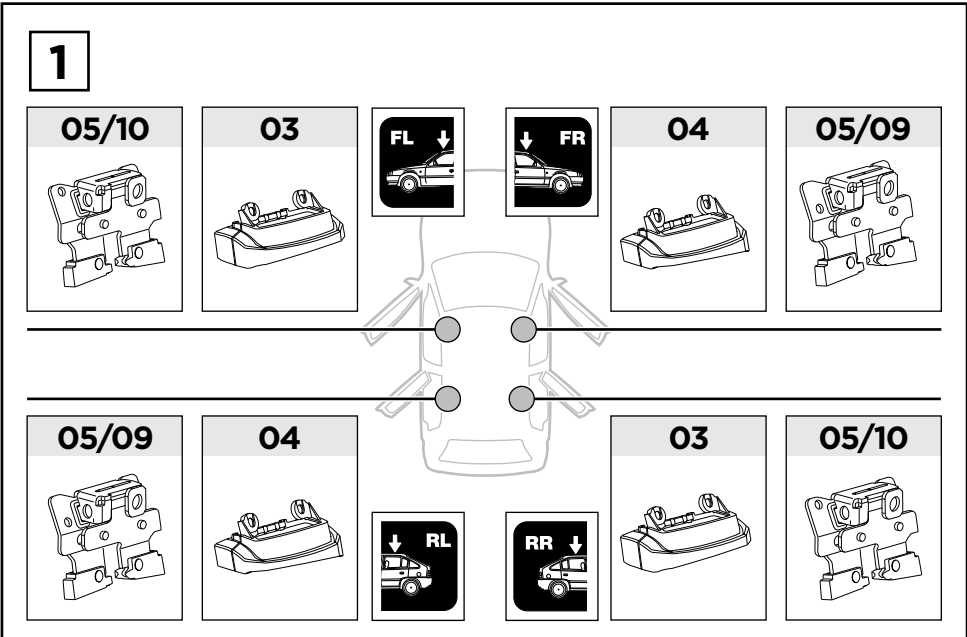
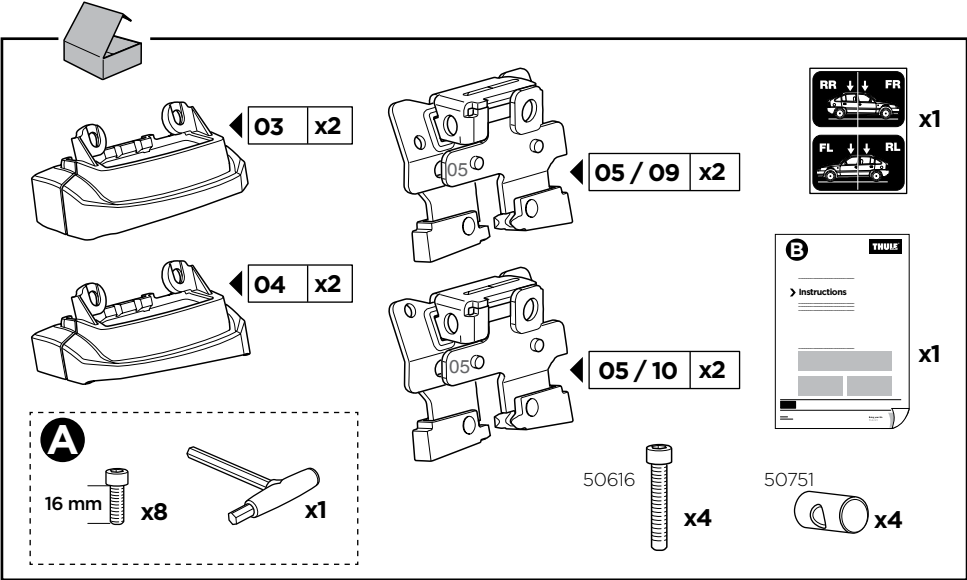
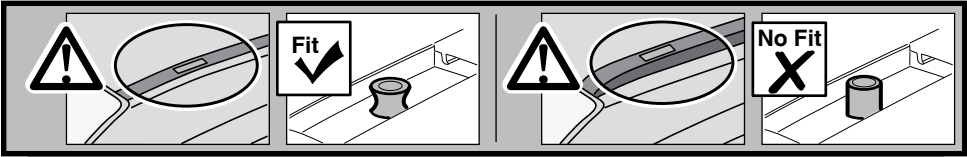

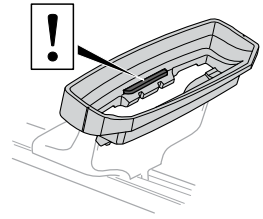
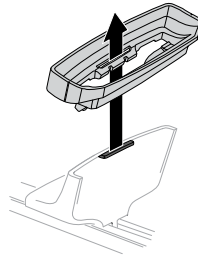
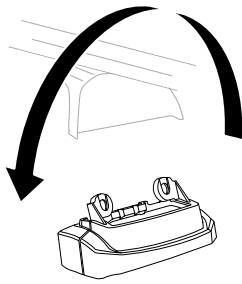
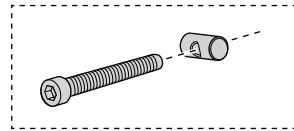
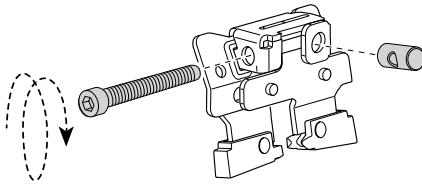
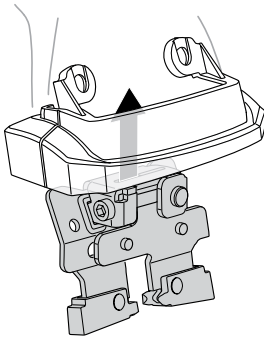
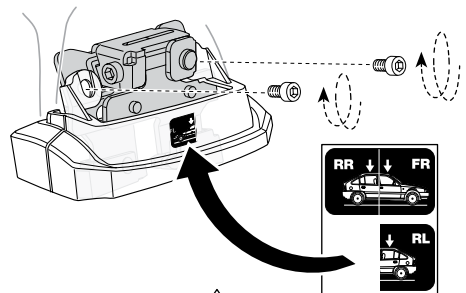
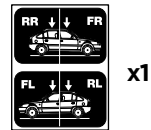
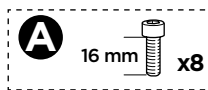
2**A****B****C**

EN Only a few turns
DE Nur wenige Umdrehungen
FR Quelques tours uniquement
NL Slechts enkele slagen
IT Solo qualche giro
ES Sólo algunas vueltas
PT Noções básicas
SV Endast några varv
DK Kun nogle få omgange
NE Bare noen få omdreinger
FI Vain muutama kierros

ET Ainult mõni pööre
LV Tikai dažī apgriezieni
LT Tik keli pasukimai
PL Wystarczy kilka obrotów
RU Только несколько оборотов
UK Лише декілька обертів
BG Само няколко завъртания
CS Pouze několik otáček
SK Len niekoľko otáčok
SL Le nekaj obratov
HR/BIH Samo nekoliko okreta

RO Doar câteva rotiri
HU Csak néhány fordítás
EL Μόνο λίγες περιστροφές
TR Yalnızca birkaç tur

بعض دورات فقط **AR**
 רק מספר סיבובים **HE**

ZH 仅几圈
JA 2～3回転のみ
KO 몇 번만 돌리면 됨
TH เพียงสองสามรอบ

3

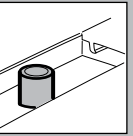
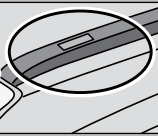
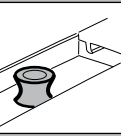
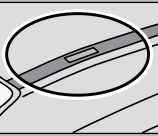
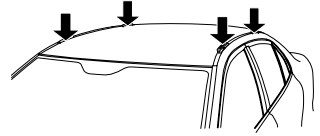

A

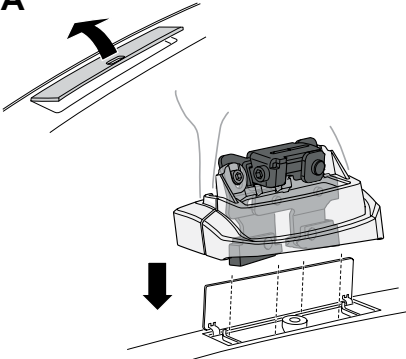

B

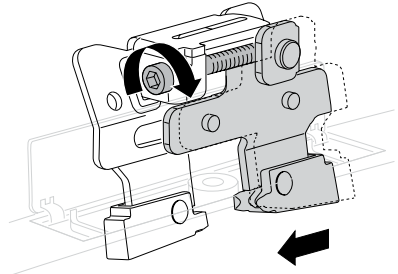

4

A

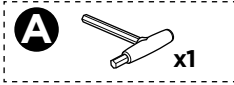

6 Nm

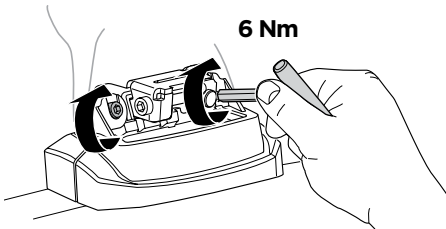

B

0-5 mm

6 Nm

