

Thule Rapid System Kit 1695

> Instructions

HYUNDAI Elantra GT, 5-dr Hatchback, *13- (With glassroof)

HYUNDAI i30, 5-dr Hatchback, 12- (With glassroof)

*North America

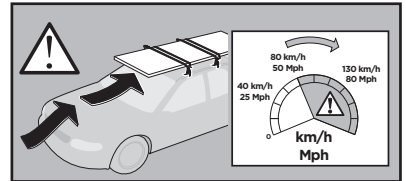
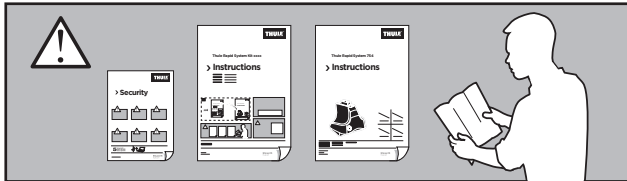
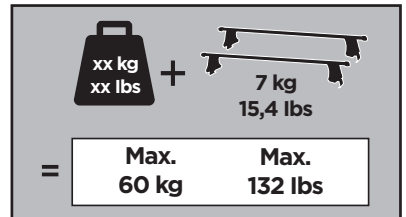
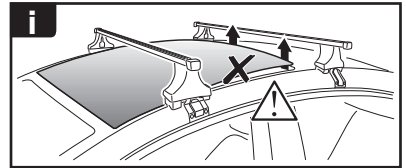
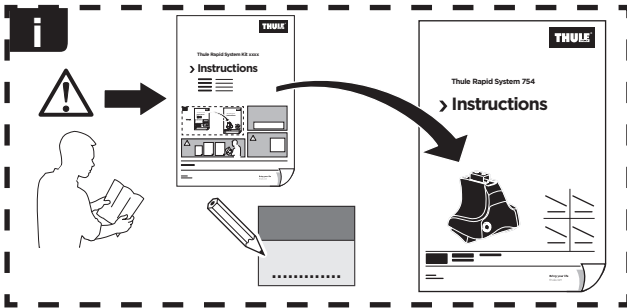

ISO 11154-E



269 x1

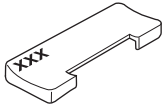

271 x2

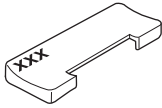

272 x1

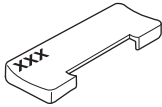

1158 x2



1192 x2



x1

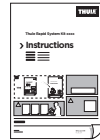

x1

1

	X (scale)	X (mm)	X (inch)
HYUNDAI Elantra GT, 5-dr Hatchback, *13- (With glassroof)	40	1051	41 ³ / ₈
HYUNDAI i30, 5-dr Hatchback, 12- (With glassroof)	40	1051	41 ³ / ₈

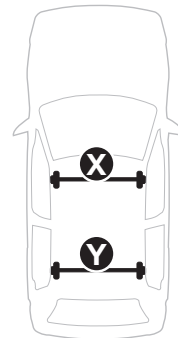
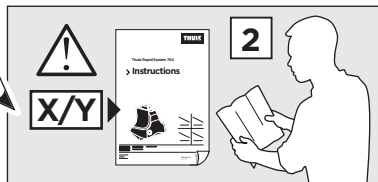
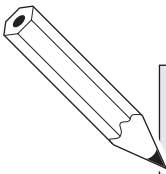

	Y (scale)	Y (mm)	Y (inch)
HYUNDAI Elantra GT, 5-dr Hatchback, *13- (With glassroof)	35,5	1006	39 ⁵ / ₈
HYUNDAI i30, 5-dr Hatchback, 12- (With glassroof)	35,5	1006	39 ⁵ / ₈

2

HYUNDAI Elantra GT, 5-dr Hatchback, *13- (With glassroof)

HYUNDAI i30, 5-dr Hatchback, 12- (With glassroof)

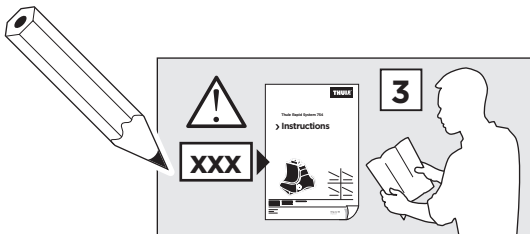
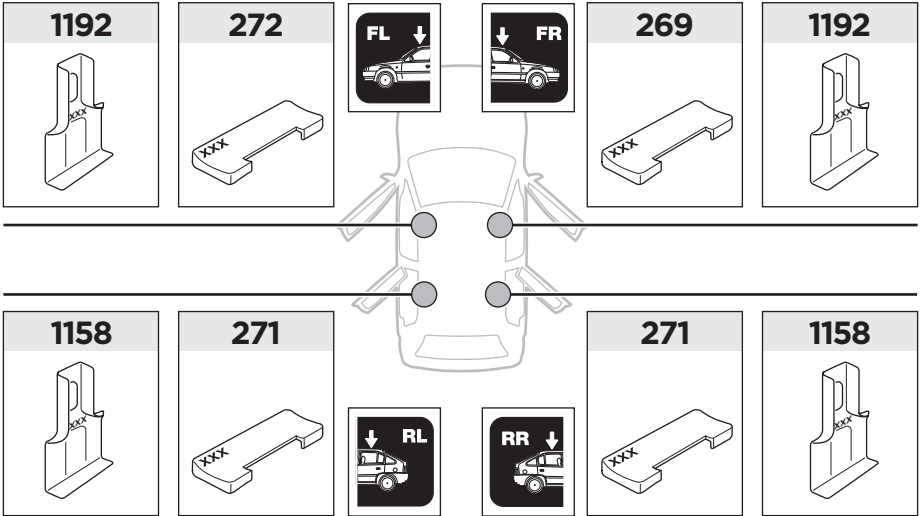

3

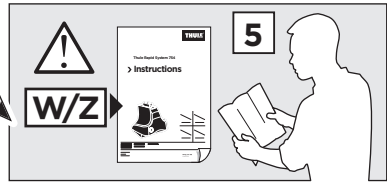
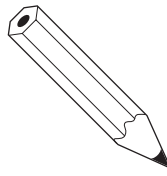

	W (mm)	Z (mm)	W (inch)	Z (inch)
HYUNDAI Elantra GT, 5-dr Hatchback, *13- (With glassroof)	180	700	7 1/8	27 1/2
HYUNDAI i30, 5-dr Hatchback, 12- (With glassroof)	180	700	7 1/8	27 1/2

