



Thule XT Kit 3175

> Instructions

CITROËN Berlingo, 4-dr Van, 19-
OPEL Combo, 4-dr Van, 19-
PEUGEOT Partner, 4-dr Van, 19-

This kit is only for vehicles with fixpoint mounting.

751 FootPack **753 FootPack**

xx kg / xx lbs + **6 kg / 13 lbs**
= **Max. 100 kg / 220 lbs**

xx kg / xx lbs + **9 kg / 20 lbs**
= **Max. 150 kg / 330 lbs**

80 km/h **130 km/h**
50 Mph **80 Mph**
40 km/h **25 Mph**
km/h
Mph

ISO 11154-E

183175

C.20190121
509-3175-01

Bring your life
thule.com

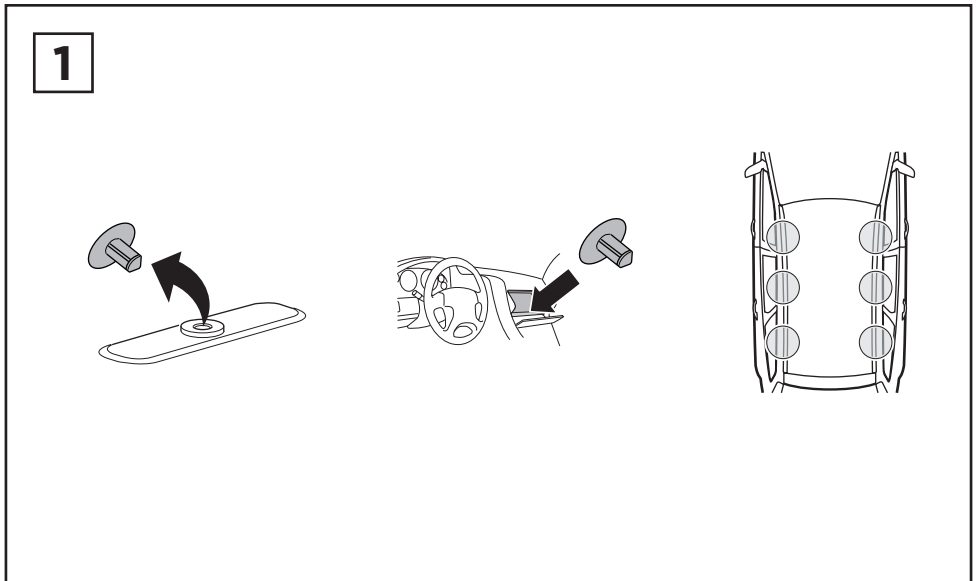
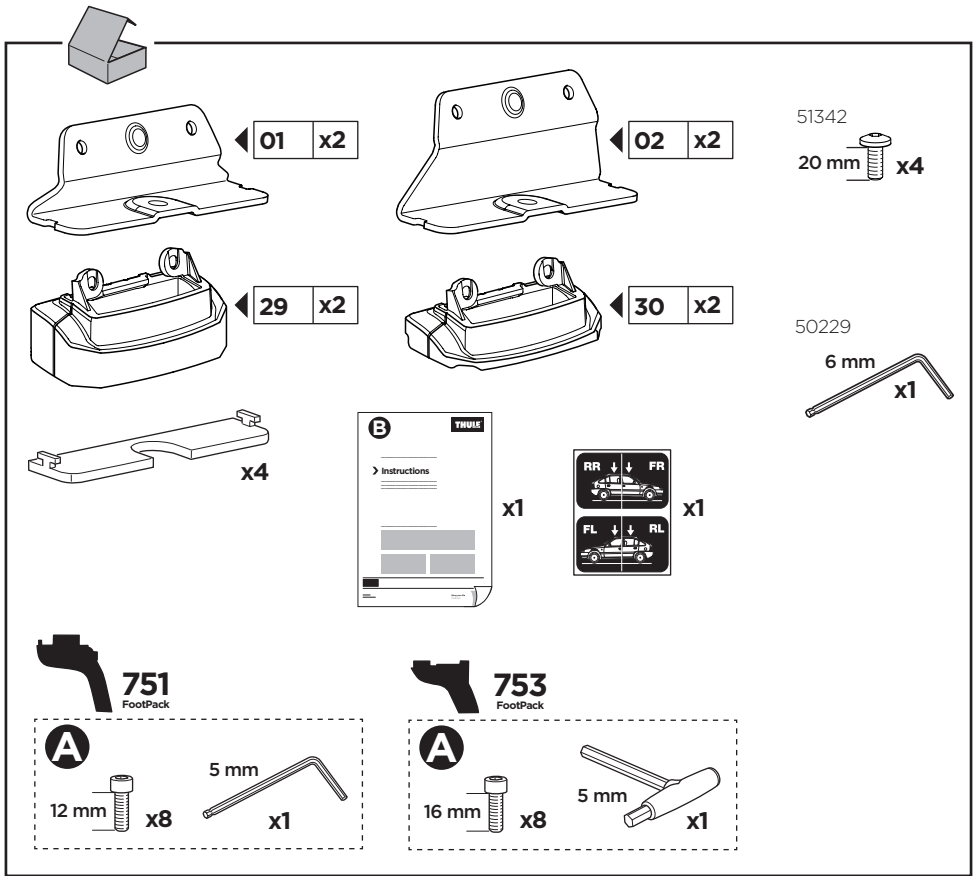

2

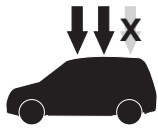
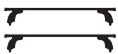

753

FootPack

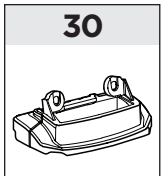
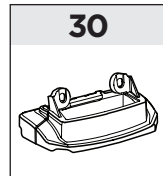
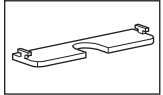
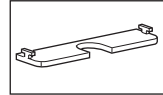
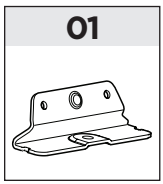
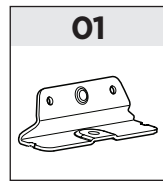
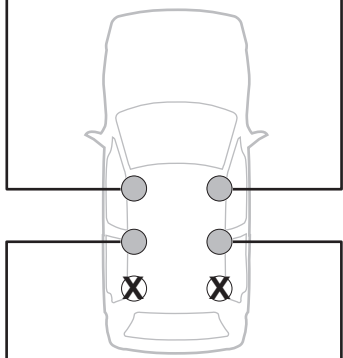
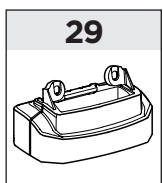
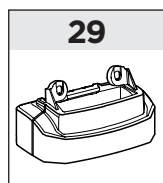
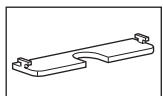
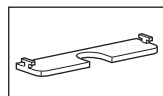
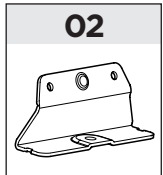
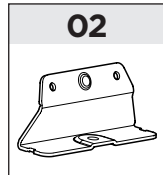

2

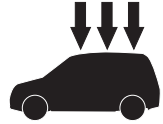

751 FootPack

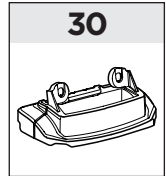
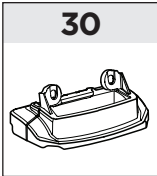
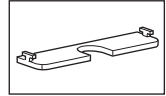
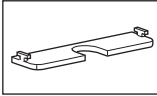
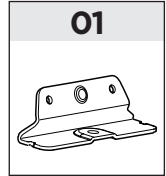
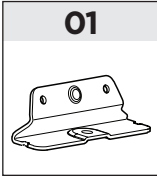

753 FootPack

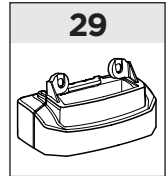
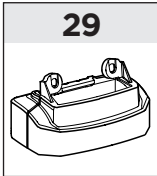
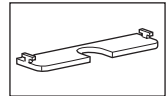
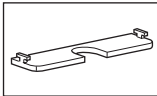
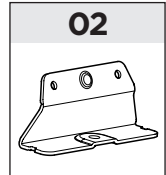
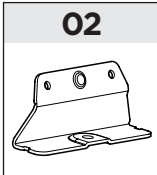

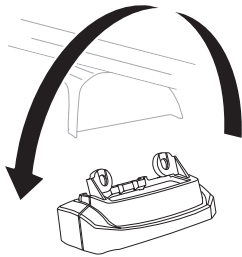
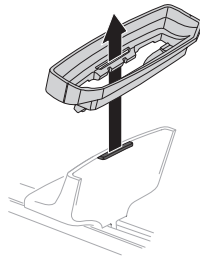
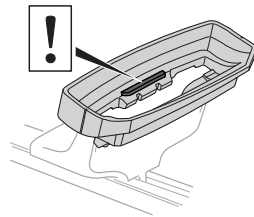
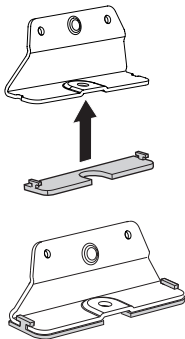
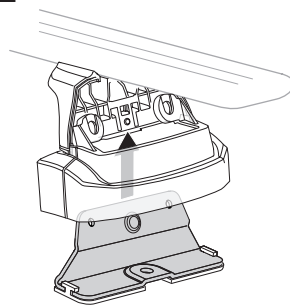
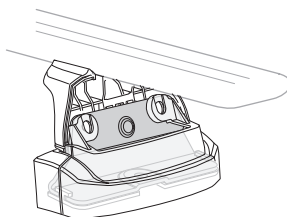
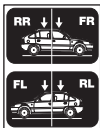
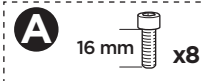
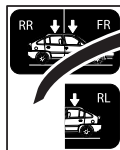
3**753**
FootPack**A****B****C****D****E****F****G****x1**

EN Only a few turns
DE Nur wenige Umdrehungen
FR Quelques tours uniquement
NL Slechts enkele slagen
IT Solo qualche giro
ES Sólo algunas vueltas
PT Noções básicas
SV Endast några varv
DK Kun nogle få omgange
NE Bare noen få omdreinger
FI Vain muutama kierros

ET Ainult mõni pööre
LV Tikai dažī apgriezieni
LT Tik keli pasukimai
PL Wystarczy kilka obrotów
RU Только несколько оборотов
UK Лише декілька обертів
BG Само няколко завъртания
CS Pouze několik otáček
SK Len niekoľko otáčok
SL Le nekaj obratov
HR/BIH Samo nekoliko okreta

RO Doar câteva rotiri
HU Csak néhány fordítás
EL Μόνο λίγες περιστροφές
TR Yalnızca birkaç tur

AR بعض دورات فقط
HE רק מספר סיבובים
ZH 仅几圈
JA 2 ~ 3 回転のみ
KO 몇 번만 돌리면 됨
TH เพียงสองสามรอบ

3



751
FootPack

A

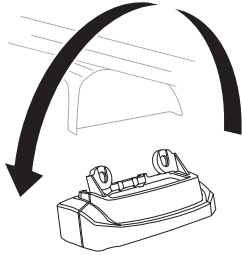

B

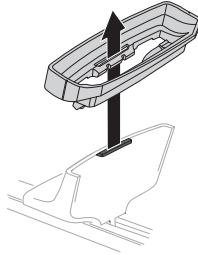

C

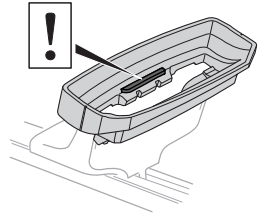

D

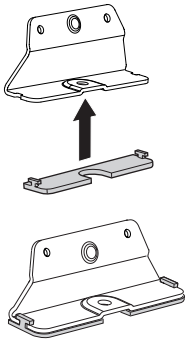

E

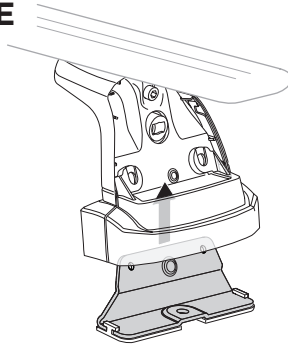

F

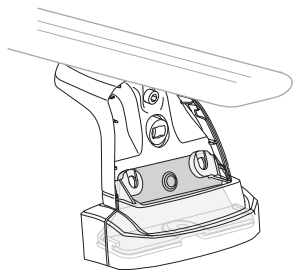

G

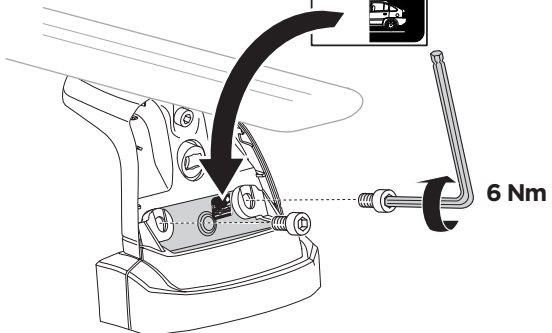
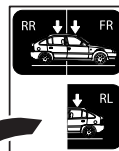
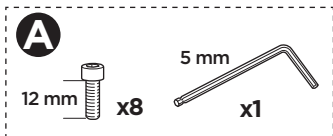

4

753
FootPack

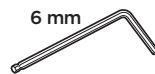
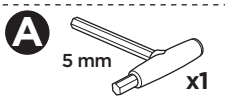

A

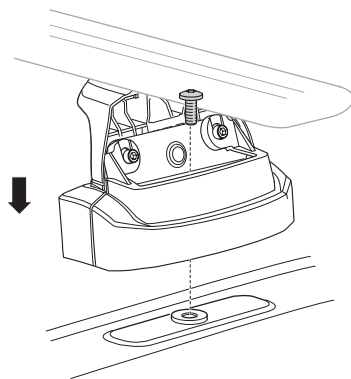

B

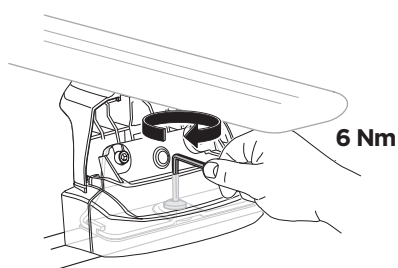
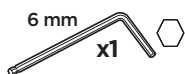

C

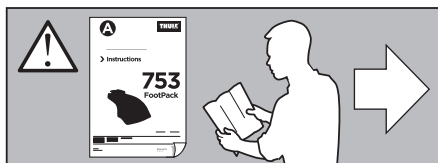
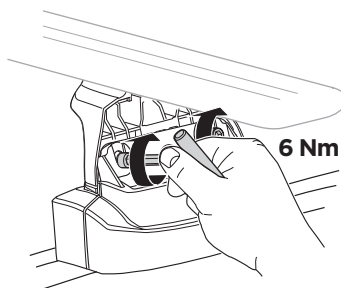
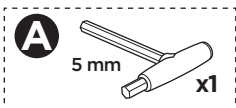

4



751
FootPack

A

5 mm



20 mm



6 mm

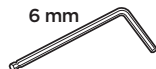

A

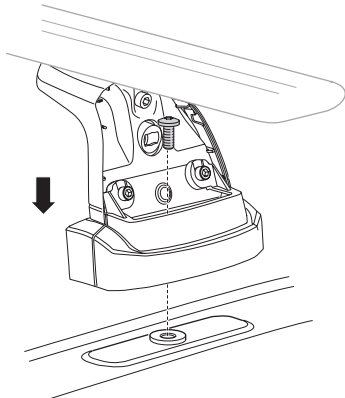

B

6 mm

x1

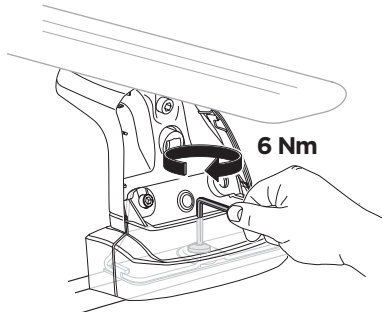
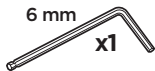

C

A

5 mm

x1

