

# ➤ Instructions

## Thule Evo Raised Rail 7104

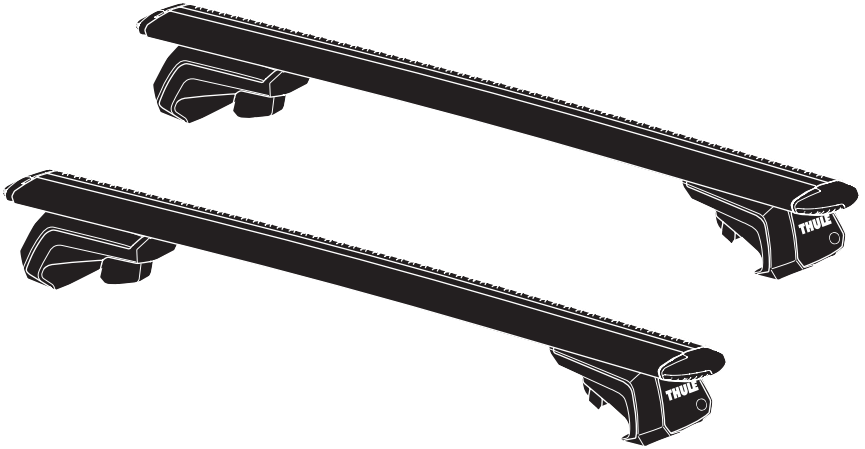

**EN** Roof mounted load carrier  
**DE** Lastenträger zur Dachmontage  
**FR** Barre de toit  
**NL** Dakdrager  
**IT** Barra portatutto da installare sul tetto  
**ES** Portaequipajes de techo  
**PT** Barra para montagem no tejadilho  
**SV** Takmonterad lasthållare  
**DK** Tagmonteret lastholder  
**NO** Takmontert lasteholder  
**FI** Katolle asennettava teline  
**ET** Katusele paigaldatav katuseraam  
**LV** Uz jumta uzstādāms kravas turētājs  
**LT** Ant stogo tvirtinamas krovinų laikiklis  
**PL** Uchwyt na bagażnik bazowy montowany na dachu  
**RU** Багажник на крышу  
**UK** Багажник для даху  
**BG** Багажник, монтиран върху покрива  
**CS** Nosič pro montáž na střeche  
**SK** Strešný nosič  
**SL** Nosilec za strešni prtljajnik

**HR/BIH** Krovni nosač tereta  
**RO** Suport încărcătură montat pe acoperiș  
**HU** Tetőre szerelhető csomagszállító  
**EL** Σχάρα οροφής για μεταφορά φορτίου  
**TR** Araç üstüne bağlanan yük taşıyıcı

**HE** מנשא מטען לגג הרכב  
**AR** حامل نقل مثبت على السقف

**ZH** 顶置行李架  
**JA** ルーフマウント型ロードキャリア  
**KO** 루프 장착 화물 캐리어  
**TH** โครงยึดของบรรทุกแบบติดตั้งบนหลังคา

**CITY CRASH**  
 Complies with ISO norm

ISO 11154-E

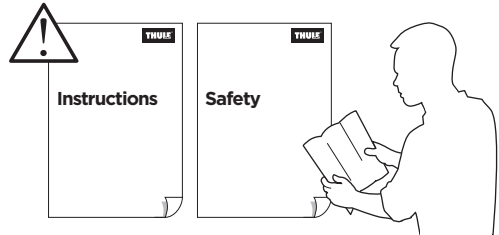

## >Mounting Tutorial

Thule Evo Raised Rail

**THULE**  
SWEDEN

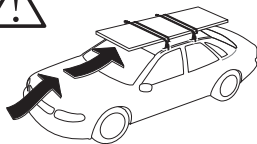

80 km/h  
50 Mph

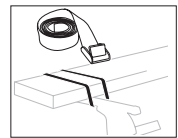
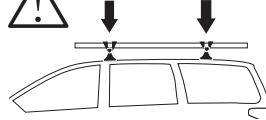

+

4 kg

5 kg

5,5 kg

10,6 kg

+

kg

= Max.  
100 kg

i



Your Key-Number

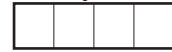

**2**  
FOOT PACK

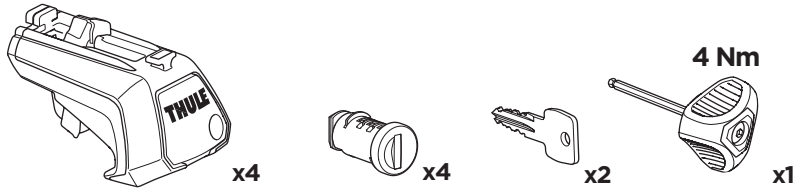

**3**  
BAR

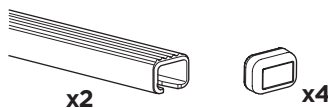
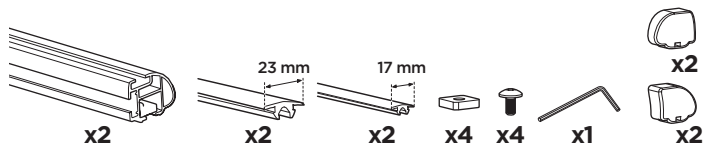
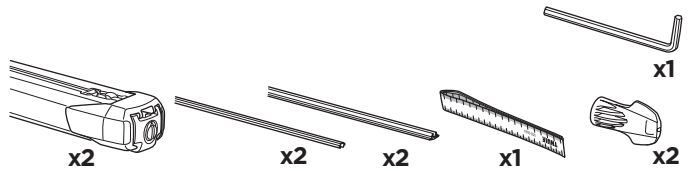
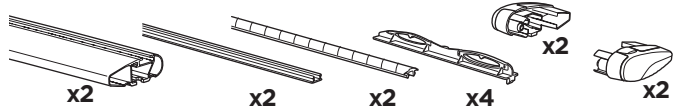
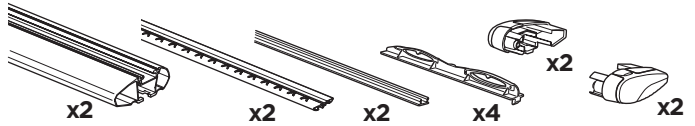



1

A

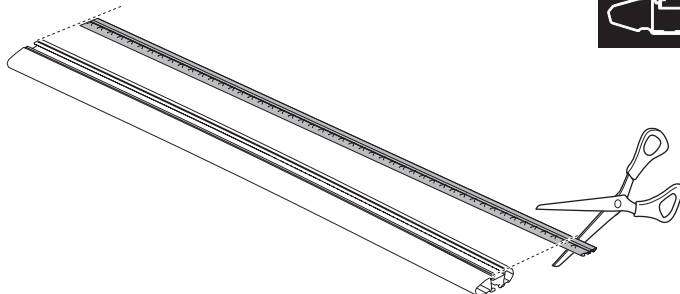

B

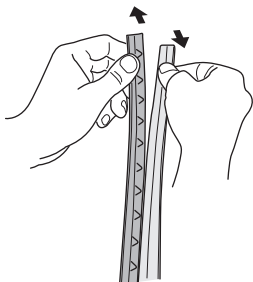

C

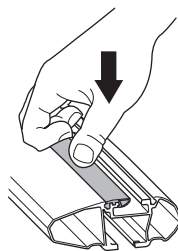
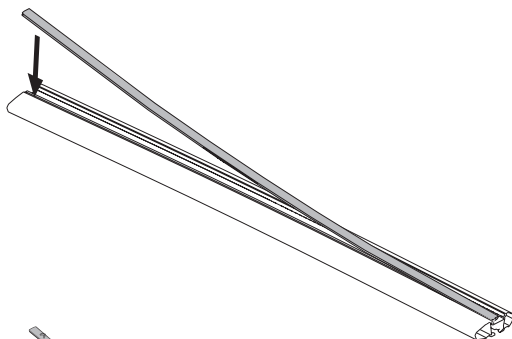

D

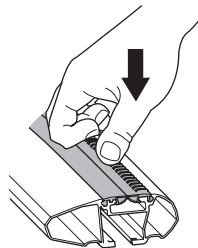
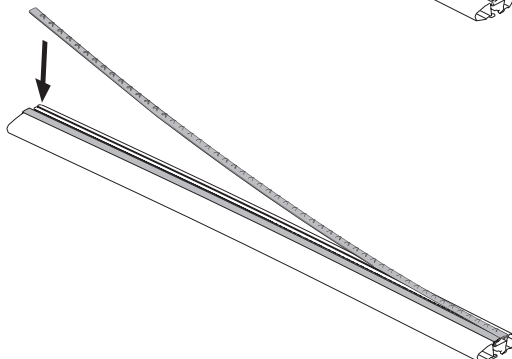

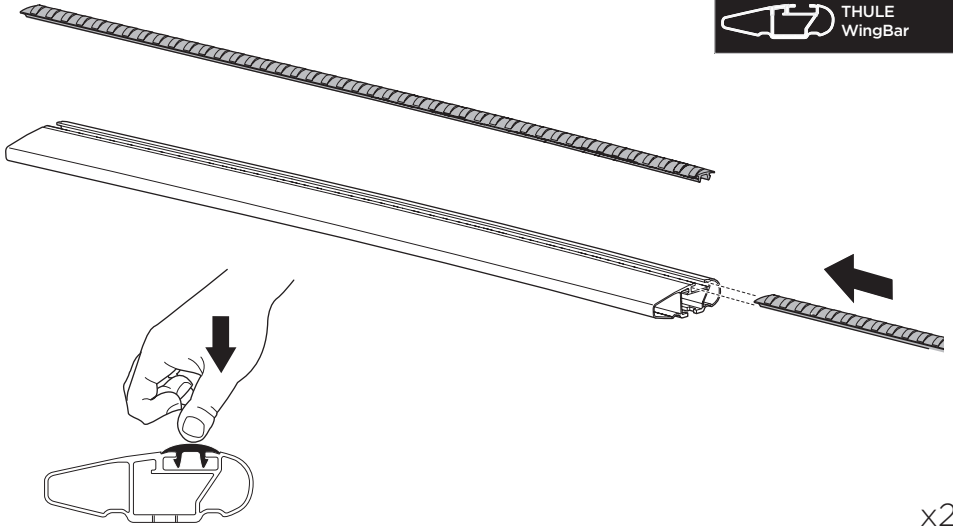

x2



2

A

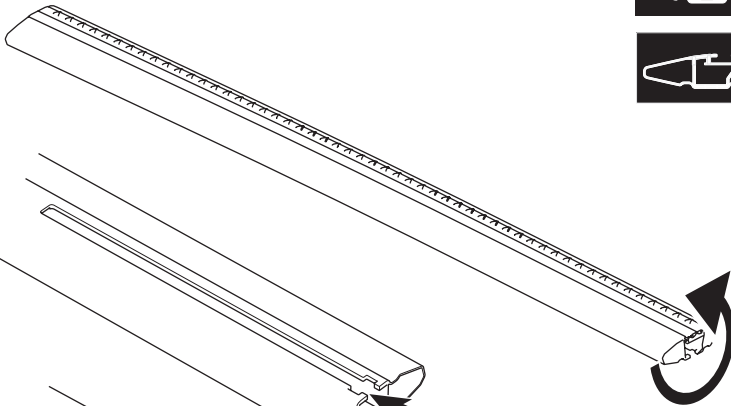

B

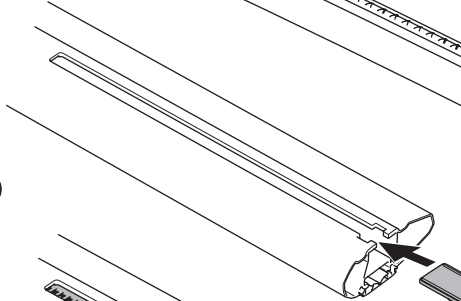

C

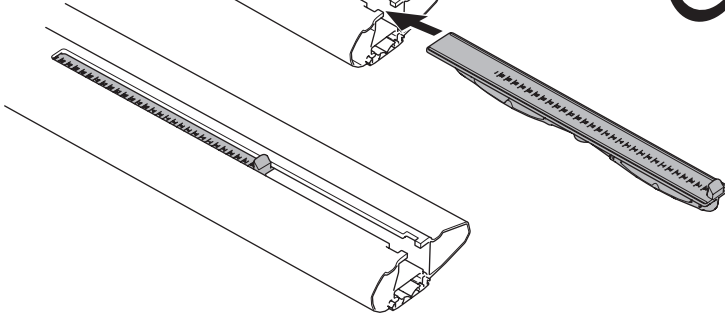

x4

3

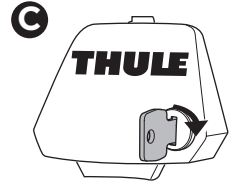
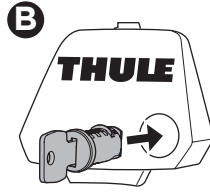
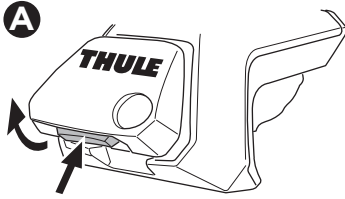

x4

4

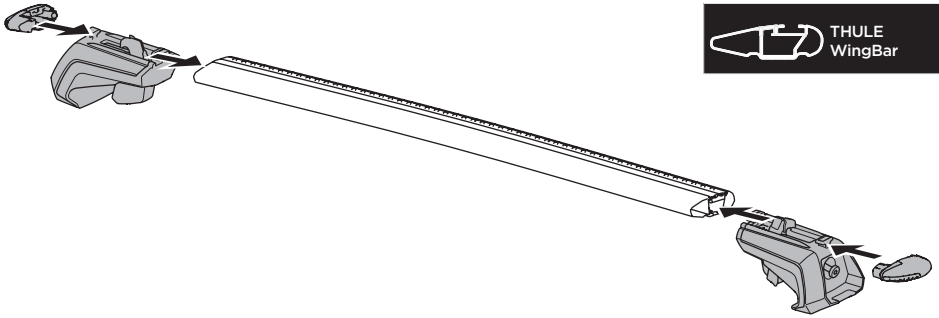

x2

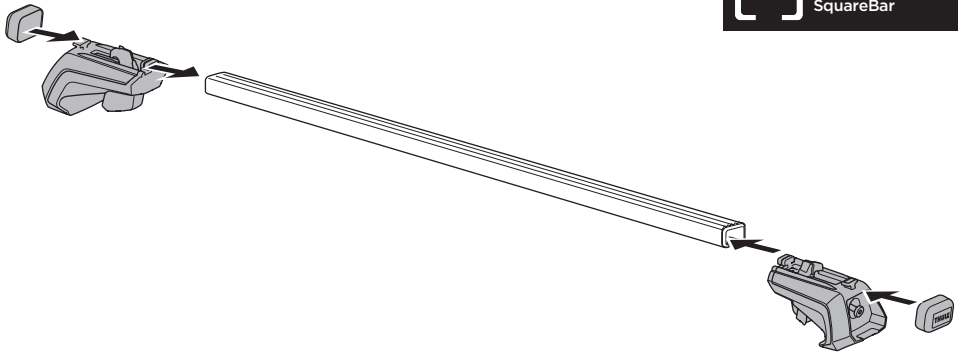

x2

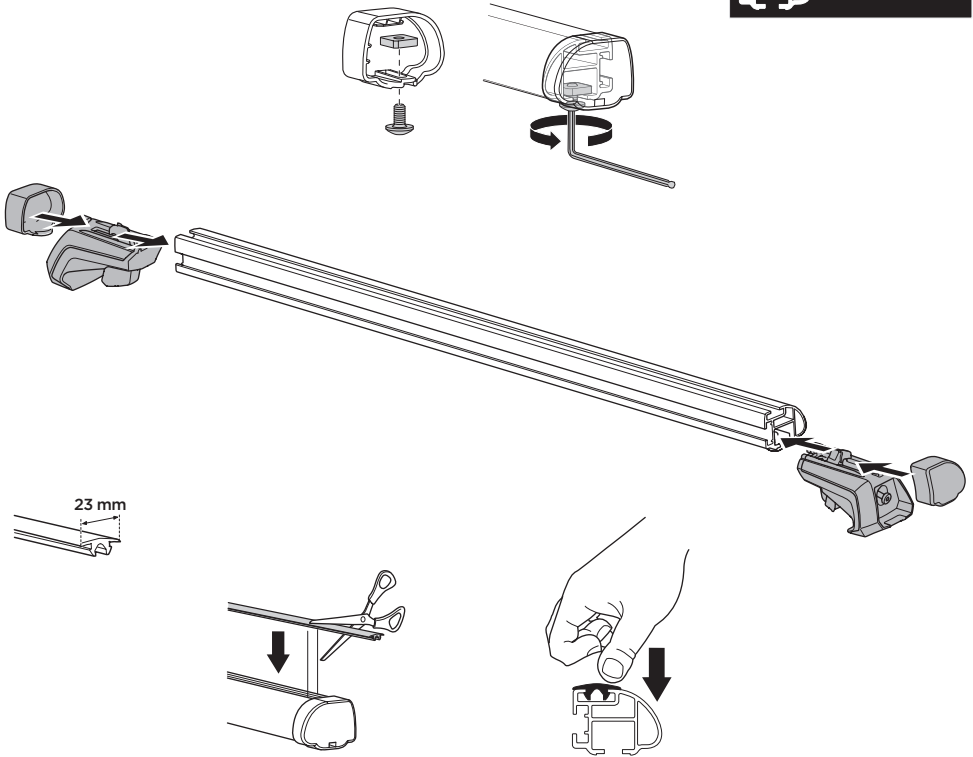

x2

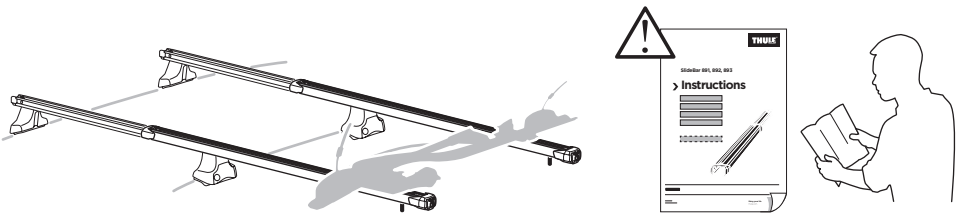

5

A

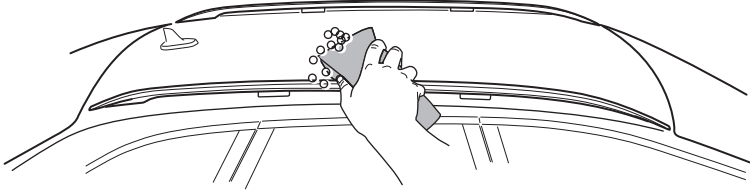

B



6

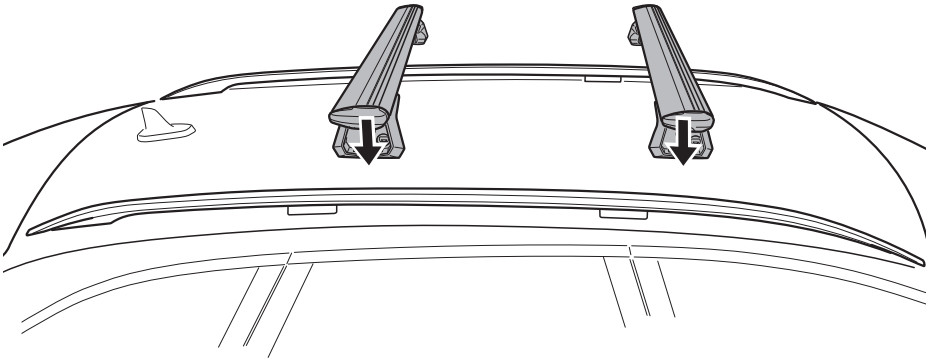
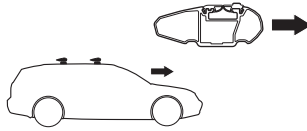



7

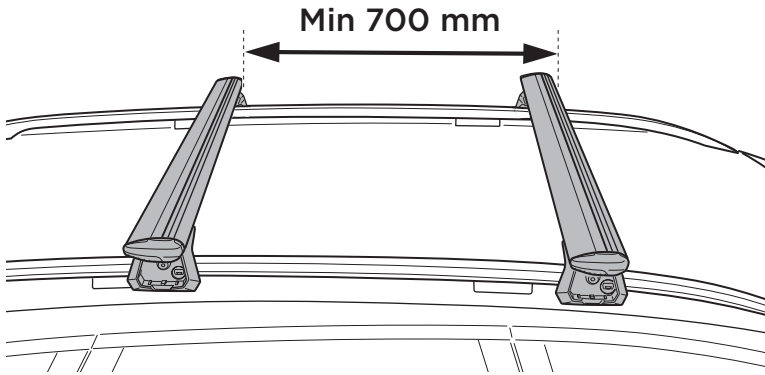

8

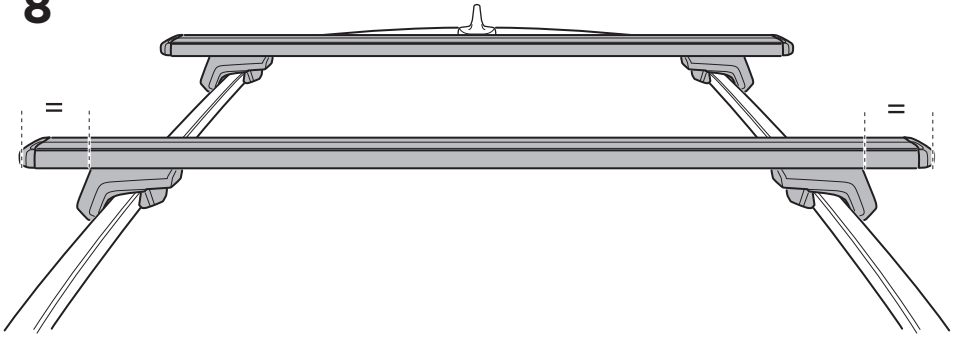

9

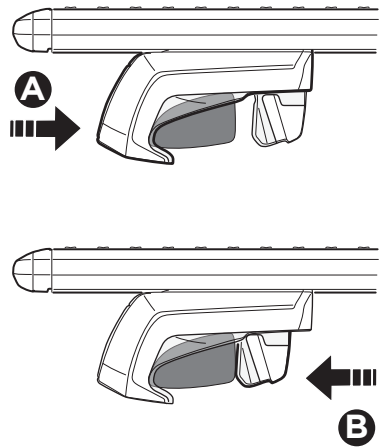
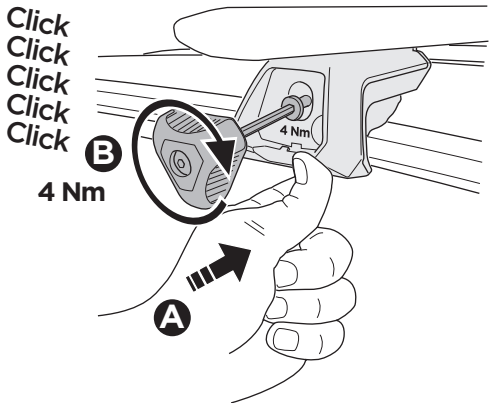

# 10

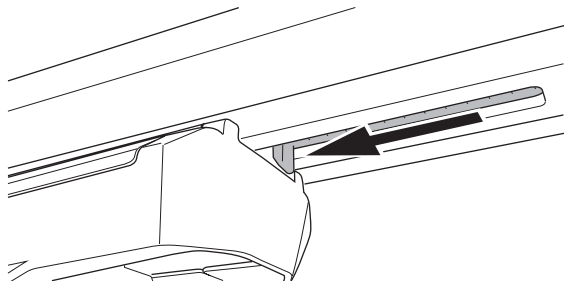

x4

# 11

**A**

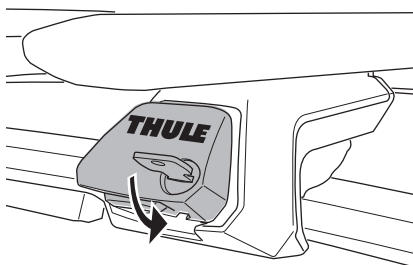

**B**

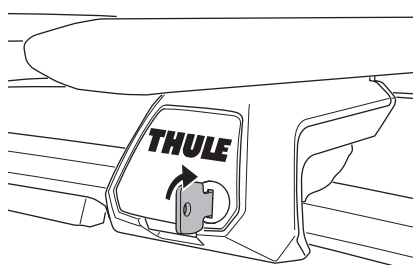

x4

# 12

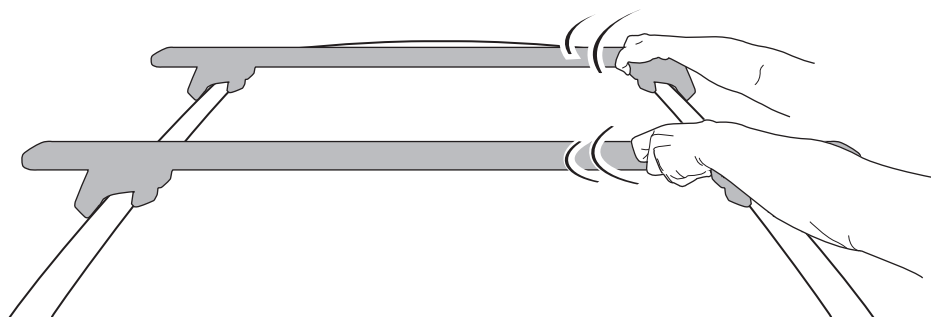

13

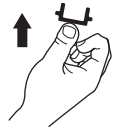
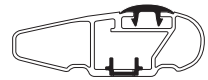
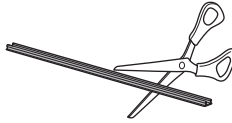

x4

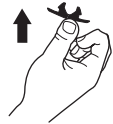
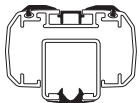
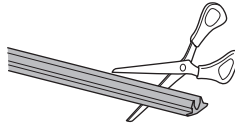
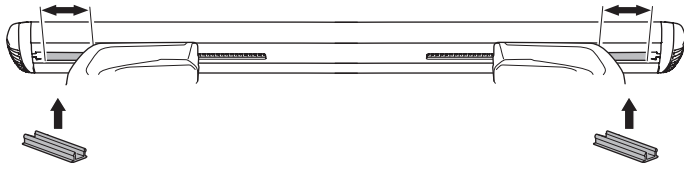

x2

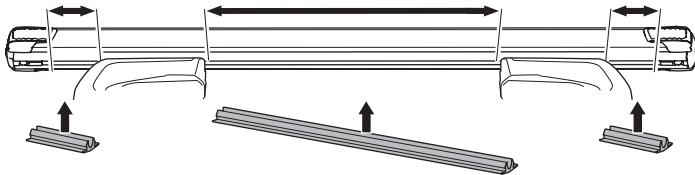

17 mm

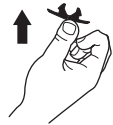
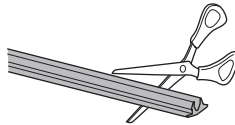
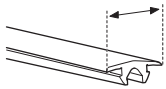

x2

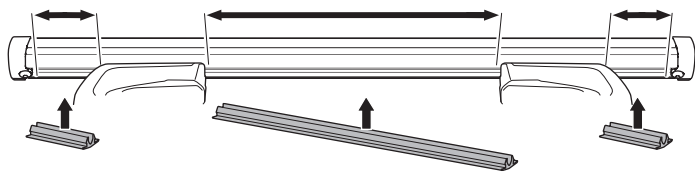

**i**

